

Automatic 20TM Nitrogen Evaporation System

Models 11220-A

DIGITAL & TIME CONTROL SYSTEM
INSTRUCTION MANUAL

ORGANOMATION ASSOCIATES INC.

266 RIVER ROAD WEST
BERLIN, MA 01503
U. S. A.

Tel: 888-838-7300

Fax: 978-838-2786

Forward - Letter from the President

Introduction

- Instrument Items Shipped
- Instrument Description
- Instrument Part Identification

Installation

- Location
- Bath Setup
- Instrument Setup

Safety Considerations - Read before operation

Operation

- Instrument Control Identification
- Planning and Preparation
- Type Z Purge Intrinsically Safe Bath Option
- Bath Operation
- Instrument Operation
- Optimization

Maintenance and Cleaning

Trouble Shooting

Technical Information

- Parts List
- Service and Returns
- Shipping - Claims for damage or shortage
- Specifications
- Wiring Diagrams
- Z-Purge NFPA Guidelines

Accessories

Other Products and Services

Contacting Organomation and its Representatives

Items Shipped

Carefully check the contents of all cartons received for damage which may have occurred in transit. Retain all cartons and packaging materials until all components have been checked against the packing slip, the component list below, and the equipment has been assembled and tested. Contact Organomation immediately if any damage or discrepancies are found.

Your shipment should contain the instrument shown below. Option codes are listed on the next page.

Cat #	Instrument Size
11220-A	20 position automated nitrogen evaporator.
NA1101	Gas Connector Tube
V12651	Flow meter 0-25 LPM for 20 position
NA0603	19 ga. x 4" Stainless Steel Needles, blunt end. 1 set 20 for Model 11220-A
B1302-R	OA-HEAT Water Bath 1100W for all MULTIVAPS
V10124	Manual for N-EVAP model 11220-A
P0636	Pasteur Pippet Adapter with flow controller, (Optional) .

Option Codes and additional items shipped

The following list contains option codes and items which may have been shipped in conjunction with the standard parts shown on the previous page. Please check your packing list and order information carefully to determine if these items are included in your shipment.

Your shipment may contain the following optional items:

Option	Description
-P	Pasteur Pipit Fittings replace SS needles and on the N-EVAP. 20 pieces are provided; reference part # P0636.
-RT	N-EVAP Instrument and OA-HEAT heating unit are coated in PTFE. Instrument is black in color. The water bath exterior is blue and the interior is black.
-T	SS Needles 19 gauge x 4" (100mm) Long, are coated in PTFE and are black in color.
-Z	OA-HEAT heating unit has been modified for the Type-Z Purge Intrinsically Safe bath option. Additional parts include: differential pressure gauge, mounting bracket, and tubing.
-2	OA-HEAT water bath is wired as a 240 Volt unit.

Instrument Description

Engineered specifically to concentrate smaller sample volumes up to 60ml, the Automatic 20 combines our proven time tested N-EVAP design with our new unique automatic endpoint technology, the Auto 20 is our most advanced design and provides both automatic and manual sample concentration.

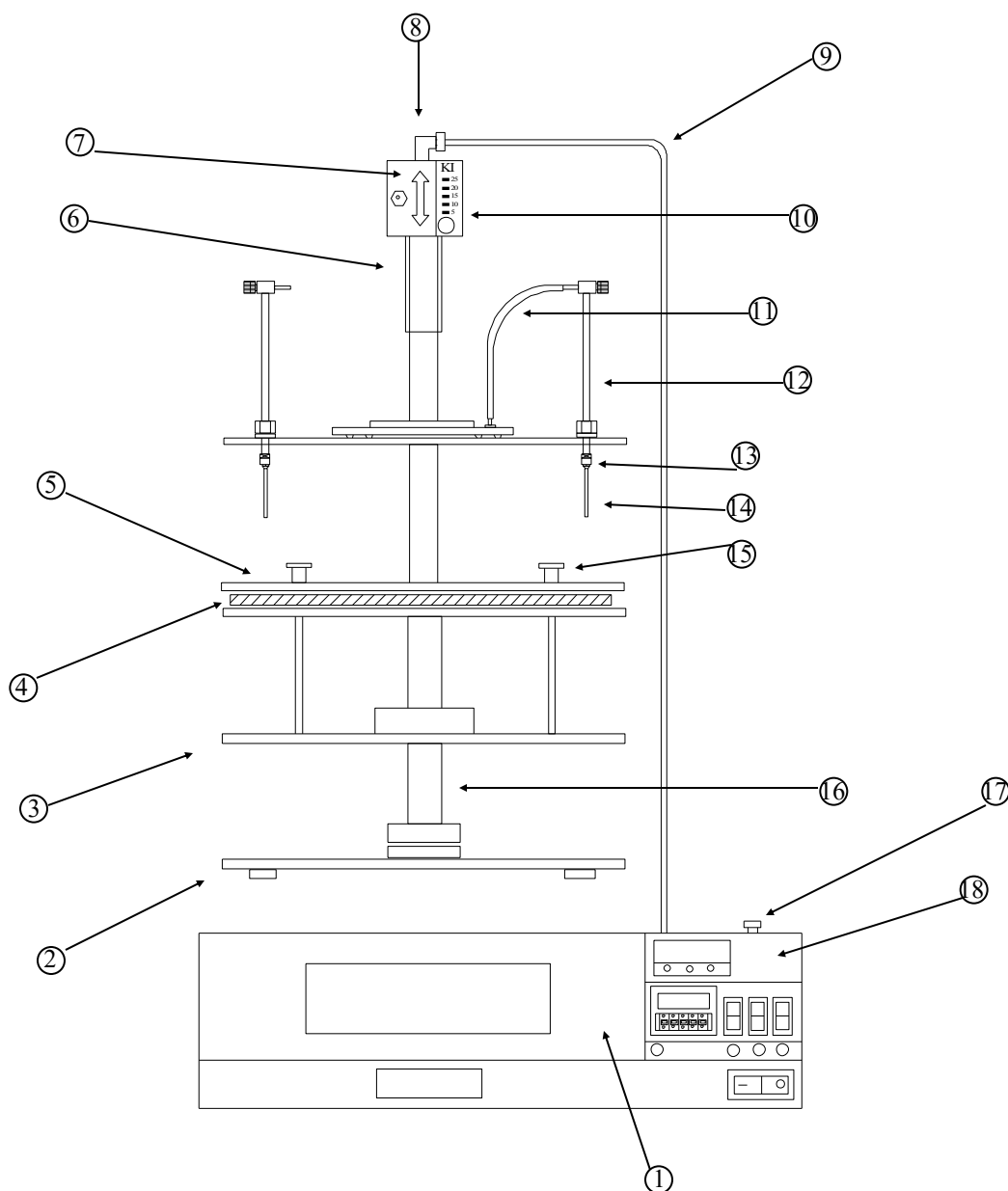

Figure 1

<u>Item</u>	<u>Part Name</u>	<u>Part Number</u>	<u>Description</u>
(1)	Water Bath	B1302-R	Square water bath, provides heat.
(2)	Stand	RFQ	Supports N-EVAP in bath
(3)	Support Tray	RFQ	Supports test tube samples.
(4)	Sample Spring	P0614	Holds and centers samples.
(5)	Sample Holder	RFQ	Holds various sized samples.
(6)	Hydraulic Cylinder	V12522	Raises and lowers sample holder.
(7)	Manual/Automatic Over-ride Switch	V12501	Controls for lifting of instrument.
(8)	Swivel Fitting	P1204	Connects gas tube.
(9)	Gas Tube	RFQ	Delivers gas to rotating instrument.
(10)	Flow Meter	V12651	Meters gas flow to samples.
(11)	Silicon Tubing	P0613	Delivers gas to each Valve Tube Assembly.
(12)	Valve Tube Assembly	P0627	Adjusts gas flow to each sample.
(13)	Luer Fitting	P0607	Connects needle or Pipet Adapter.
(14)	Blunt Needle	NA0603	Delivers gas into sample tube.
(15)	Thumbscrew	P0612-N	Adjusted Sample Holder
(16)	Center Tube	RFQ	Allows mounted hardware to rotate.
(17)	Regulator/Gauge	RFQ	Pressure reduction to instrument.
(18)	Control System	RFQ	Digital / Time control system.

Location

The Automatic-20 Evaporator System should be located on a bench top or in a chemical fume hood if hazardous or flammable materials and solvents are to be used. The location should provide the necessary support services for the instrument. These include electrical power (required for water bath) and a clean inert gas source (air or nitrogen). Please review the Specifications Section for further information.

Bath Setup

1. Position the bath on a stable flat surface such as a lab bench or in a chemical fume hood.
2. Turn the bath rocker switch to the “OFF” position.
3. Turn the heat and time switches to the center “OFF” position.
4. Plug the bath electrical cord into a 3 wire grounded electrical outlet rated for 110-120 VAC, 50-60 Hz, single phase, 15 amps.

Optional 220 VAC baths are clearly marked and should be plugged into a 3 wire grounded electrical outlet rated for 220-240 VAC, 50-60 Hz, single phase, 15 amps.

Dry Bath Setup (Continued)

6. Type-Z Purge Intrinsically Safe Bath option - **If you do not have this option, please proceed to the next section.** Procedures for operating this system may be found in the Operation Section. Quick start instructions are posted on the front of the bath. A copy of the NFPA (National Fire Protection Assoc.) guidelines for intrinsically safe equipment are in the appendix. Please refer to Figure 3 below for parts list and installation.
- A. Install the Type Z Purge Gauge Assembly to the rear of the bath as shown. The bracket attaches to the rear of the bath and is held in place by a 6-32 x 1/4" screw on the shoulder spacer and by a 1/4" bulkhead hex nut on the gas inlet fitting.
 - B. Connect the small white silicone tube attached to the gauge to the gas inlet fitting using the compression nut provided.
 - C. Attach the filter with 5 foot tube to the plastic elbow fitting located at the base of the bath. Insert the filter into the fitting and tighten the nut. Connect the tube to a clean gas source.
 - D. Test the system by turning on the gas flow to the Z Purge System. Adjust the gas flow until the gauge reads 0.1 inches water pressure.

WARNING - If this unit is located in a hazardous area where volatile fumes are present, the Z-Purge System must be activated for a minimum of 10 minutes prior to activation of bath power. Please review the Safety and Operations sections.

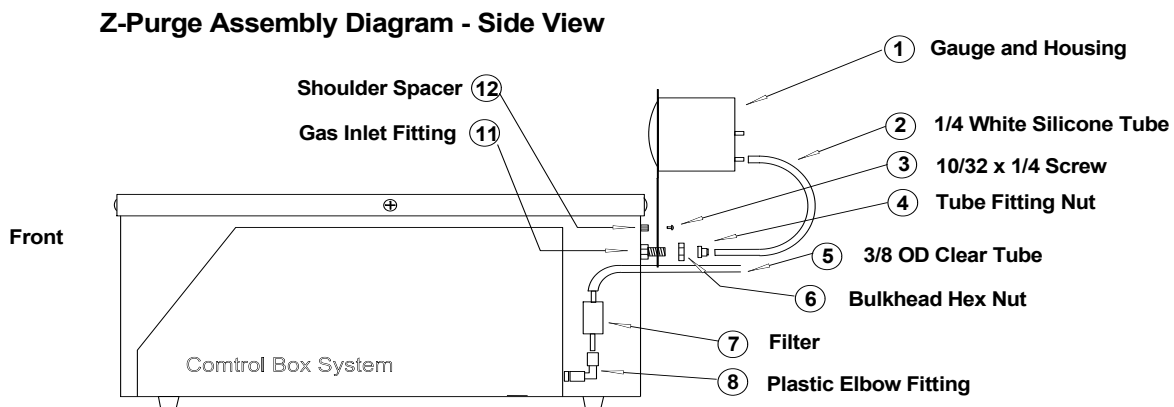
**FIGURE 3**

Bath Setup (Continued)

7. Flow meter Assembly - Provided with all N-EVAP Systems. If an OA-HEAT bath was purchased without an N-EVAP instrument, proceed to the next section.
 - A. Attach stainless steel gas supply tube to flow meter gas line (back of instrument).
 - B. Place stand and upper instrument in bath and connect stainless steel gas supply tube to swivel fitting (top of instrument).
8. Connect the black connector tube to the lower left connector on the rear of the unit labeled GAS IN. Connect the other end to a suitable gas source.
9. Pressure Reducing Regulator is standard on all systems utilizing a side mounted control box. This item is pre-installed onto the top of the control box immediately in front of the flow meter. Adjustment range is 0 - 50 psig.
10. Fill the bath with water to within one inch of the rim, approximately (25mm). To reduce scale and mineral buildup, de-ionized or distilled water may be used.

- (1)Flow Meter Gas Line
- (2)Reset Switch
- (3)Power Supply
- (4)System Gas Input

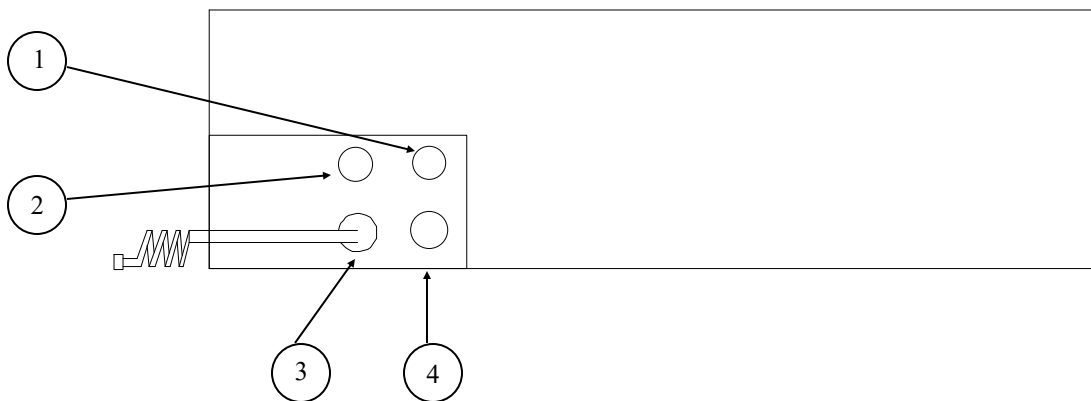
**Figure 4**

Instrument Setup

1. Place stand and upper instrument into water bath.
2. Make all necessary gas connections.
3. Using the included coiled gas supply line, connect instrument to clean gas source.
4. Plug power cord in to 110/220v outlet.
5. Install 4inch x 19 gauge needles into each positions respective luers.
6. Flip manual/automatic switch (top of instrument) into down position.

Safety Considerations

READ THIS SECTION BEFORE EQUIPMENT OPERATION!

This equipment is designed for use in the Analytical or Environmental Laboratory by trained laboratory personnel for evaporative applications. Use of this equipment beyond its stated intended purpose and operating parameters is not recommended and will be the sole responsibility of the user. This equipment should not be modified or altered. Organomation assumes no liability for any misuse of or modification to this product and such misuse or modification will immediately void all warranties.

This equipment should be used in accordance with the operating instructions contained in this manual. For alternative uses not covered in this manual, please contact Organomation Associates technical department for product suitability, safety, and alternative operating instructions.

The following are general safety guidelines recommended when using this product. Please consult your laboratory safety officer for any additional safety steps which may be necessary for your specific application or material.

1. Thoroughly review your MSDS (Material Safety Data Sheets) for all chemicals to be used with this equipment.
2. Do not use this equipment with materials with auto ignition points below 150 °C.
3. Hand and eye protection are required when using this product. Additional protection may be required with respect to the materials being used. Please consult your laboratory safety officer.
4. This product should be used in a chemical fume hood with adequate ventilation.
5. Do not move the product when hot. Scalding from bath water may result.
6. Do not open bath enclosure while energized - SHOCK HAZARD!
7. Repairs of electrical components should be conducted by a trained electrical technician. Incorrect replacement parts or assembly may damage the product and create a serious safety hazard for the user. Factory repair is highly recommended.
8. **Highly flammable materials such as Petroleum Ether should not be used with this product unless the Type-Z Purge intrinsically safe bath option is installed and operating.**
9. Use of acidic or base materials may damage this product and are not recommended unless the product was ordered with the optional protective coating in PTFE.

Instrument Controls - Main Control Panel

- Digital Controller** - Controls bath temperature
- Timer Controller** - Controls timed functions when selected. Used for bath preheat or automated control of services.
- Time Switch** - Starts or resets timed operation, momentary switch.
- Heat Switch** - Selects manual or timed control of heat system.
- Gas Switch** - Selects manual or timed control of gas system.
- Time Light** - Green, indicates timed operation in progress.
- Alert Light** - Red, indicates timed operation complete or inactive.
- Heat Light** - Amber, indicates heat system is active.
- Gas Light** - Amber, indicates gas system is active.

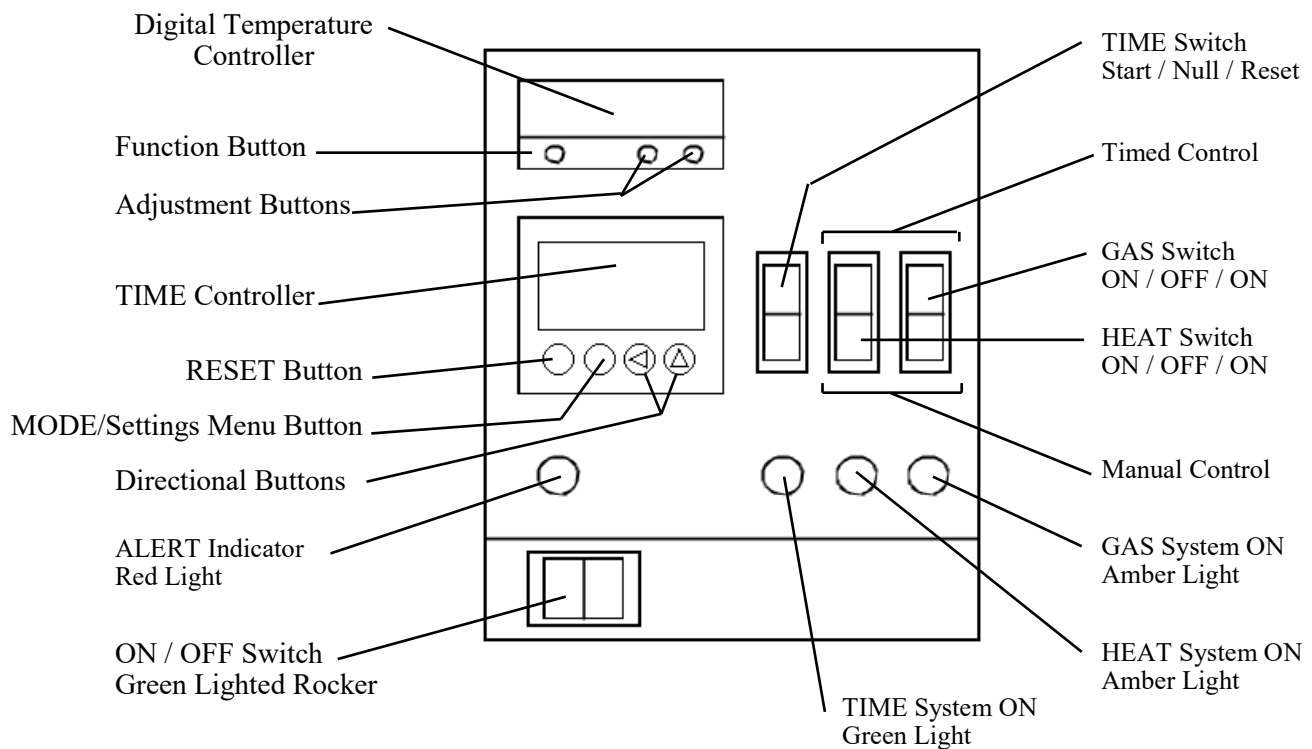

Type Z-Purge Bath Operation - Optional

What It Does

The Type-Z Purged system prevents ignition of flammable materials caused by contact with electrical components inside the heating unit.

How It Works

The concept behind this purge system is to create a small positive pressure gradient inside the bath case. By carefully sealing the heating unit or control enclosure, a small flow of clean air or inert gas will create a slight positive pressure within the enclosure. It is important to note that there is constant leakage out of the enclosure. In this way the enclosure is continually purged. The pressure gradient prevents flammable vapors and occasional spills from entering the enclosure where arcing components or high surface temperature heaters might cause ignition. The use of an inert gas such as nitrogen enhances the technique by removing all Oxygen from the enclosure. By purging the enclosure for 10 minutes, the gas volume within the enclosure is replaced multiple times ensuring that no flammable vapors remain which may have entered while the purge system was inactive.

The passive system is not tied to the electric heating system in any way. It is up to the operator to maintain the positive differential pressure within the system during operation. There is no safety interlock on failure.

Operating Procedure

1. Turn on the gas flow to the Z-Purge System. Purge gas may be clean air or inert gas such as nitrogen. The use of nitrogen is recommended.
2. Adjust the gas flow until 0.5 inches water pressure is maintained on the gauge mounted on the heating unit.
3. Purge the bath for 10 minutes before engaging the electrical system.
4. After 10 minutes the gas flow may be adjusted to 0.1.
5. Turn on the electrical heating unit. The purge rate must be maintained.
6. Proceed to the next section.

Planning and Preparation

It is important to thoroughly understand the procedures and equipment operation prior to the use of the equipment. High speed nitrogen evaporation requires a balance of sample volume, nitrogen flow, bath temperature, needle position and adjustment. Improper use can impair performance, contaminate samples or result in loss of samples. Environmental conditions are also important, examples include hood airborne contaminants, gas purge purity, and sample handling procedures. If you are unfamiliar with the use of the N-EVAP System or are working with a new procedure, it is recommended that a trial run be made using a sample blank to determine optimal operating conditions.

The N-EVAP System is designed to handle up to 20 samples simultaneously. Glass or plastic tubes from 10 to 30mm OD and up to 150mm height may be accommodated. Centrifuge tubes, scintillation vials, and small beakers may also be used. Choice of SS needles or disposable glass pipets (fittings) are available. The N-EVAP System is manufactured utilizing inert materials. The FDA approved tubing used in the gas distribution system is 100% free of phthalate (Plasticizer) presence.

WARNING!!!

The use of samples containing ether based, fuel, munitions, or other extremely flammable or explosive materials, compounds, or residues should not be used in this equipment.

The use of OAI equipment in any hazardous location or with hazardous materials is not recommended, endorsed, or warranted by OAI and any such use is at the sole discretion of and is the responsibility of the user. A Type -Z Purged Intrinsically Safe Bath Option is available for additional safety.

Even equipped with this option, extreme care and caution must be exercised when using these materials. The equipment must be placed in a location with adequate ventilation and safe guards. Recommendations include fire suppression system, shatter proof glass, and adequate shielding for personnel. No other electronic devices should be used in the same location unless they are either Z-Purge protected or are explosion proof. No flammable solvents should be stored in this location. Materials capable of forming peroxides prior to or during evaporation must be stabilized with sufficient anti-oxidant or they should not be used. Under no circumstances should this equipment be used with materials capable of auto ignition below 210 Degrees Centigrade or with materials containing peroxides.

The Type Z Purged Intrinsically Safe Bath Option meets the requirements as set forth by the National Fire Protection Association (NFPA) for electrical equipment in Class 1, Division I and II locations. **OAI equipment has not been tested to any safety standard for use in hazardous locations or with hazardous materials. No endorsements have been made or given by the NFPA or Underwriters laboratories (UL) as regards OAI equipment or its use in this regard.** Please contact Organomation Associates Technical Support if you have any questions concerning the use of Type Z Purged equipment or questionable materials in OAI equipment.

Instrument Operation

1. Press the reset button on the GFCI (if present).
2. Turn the bath rocker switch on.
3. **Digital Electronic Control** - Adjust the digital controller to the desired temperature set point.

The controller set point may be adjusted by depressing the “*” on the front panel and depressing the up or down arrow keys to the desired temperature. Release the “*” key when the temperature desired is shown on the display. This setting will be retained even after the system is turned off.

To view the current set point, depress and hold the “*” key. Release when done.

Note: The controller set point can be set above the maximum heating capability of the bath it is mounted in. Doing so will cause the bath to operate continually at 100% heat without temperature control. This type of operation defeats the purpose of the controller, may cause a safety problem, and is not recommended.

Automatic 20 water bath maximum temperature 100°C.

4. Manual Gas and Heat Control
 - A) To operate the heat system automatically, depress the heat switch to the upper position. The Amber heat light will glow indicating the heat system is active. Temperature will be controlled by the digital temperature controller.
 - B) To operate the gas system manually, depress the gas switch to the lower position. The Amber gas light will glow indicating the gas system is active. The gas system is controlled by a solenoid valve located within the control box. When active the solenoid is open allowing gas flow to the flow meter and subsequently to the needle valves on the instrument.
 - C) To turn off either service, simply return the switches to the middle “OFF” position.







Bath Operation

5. Timed Gas and Heat Control

The time control system allows several operating modes which can be set for different operations. The timer may be used to preheat the bath in the morning prior to use, to shut down the system after a specific period of time (unattended operation), or for non-dryness endpoint operations.

Preheat Bath Timed Operation

To begin heating the bath automatically prior to use the following morning, please follow the procedures below.

- A) Fill the bath with water to within 0.5 inches of the bath rim or up to the overflow port if so equipped.
- B) Turn the bath on.
- C) Hold the MODE  button until menu screen appears.
- D) Screen to read “out.n” to select output operation mode, use directional arrows   to select program “ond.1” (On Delay). Hit MODE  once to continue to select time range.
- E) Select time range under “t.rnG”, use directional arrows   to determine the desired range using h (hour), m (minute), s (second).



Hold MODE  to return to standby.

Other menu options are not vital to the Preheat Bath process.

- F) In standby, calculate the amount of time that will elapse from the point the bath will be left until it will be needed the following day less 1 hour for heat up time.

Example: You leave at 5:30 PM and plan to arrive at 7:00 AM and want the bath heated and ready to go.

Elapsed time is 13.5 hours less 1 hour for heating leaves 12.5 hours.

Use directional arrows   to set desired time, for this example: 12^h30^m. Hit MODE  once to confirm time.

- G) Set the heat switch to timed operation.
- H) Set the gas switch to the middle position (OFF).
- I) Press the start switch to begin the timed countdown operation. At the completion of the operation the bath heat will be turned on automatically.

NOTE: To stop a timed run at any point simply push the reset switch.

Bath Operation (continued)

5. Timed Gas and Heat Control (Continued)

Automatic shutdown of gas or heat services - unattended operation

To shut down the bath services after a period of time during a sample evaporative run, ideal when each sample is to be taken to dryness and the operator will not be present at the completion of the run. Please follow the procedures below.

- A) Hold the MODE (MD) button to enter menu screen.
- B) Screen to read “out.n” to select output operation mode, use directional arrows ⏪ ⏩ to select program “ofd” (Off Delay). Hit MODE (MD) once to continue to select time range.
- C) Select time range under “t.rnG”, use directional arrows ⏪ ⏩ to determine the desired range using h (hour), m (minute), s (second).

Hold MODE (MD) to return to standby.

Other menu options are not vital to the Preheat Bath process.

- D) In standby, use directional arrows ⏪ ⏩ to set time that is most ideal for the period necessary to process the sample. As most samples will vary slightly in their evaporative times to dryness, an addition period of time should be allowed prior to shut down. Ten to twenty minutes should be adequate.

Example: You wish to process 18 samples in 16 x 100mm test tubes to dryness. Experience has shown that this takes approximately 25 minutes to complete. As you are expected in a meeting which may take an hour or more, you should use the automatic time system as there is no need to waste unnecessary gas flow:

Evaporation time is 25 minutes plus 10 minutes for variance, this gives 35 minutes. Set the timer as follows: 35^m00^s

Hit MODE (MD) once to confirm time when set.

- E) Set the heat switch to timed operation or manual to bypass timed control.
- F) Set the gas switch to the timed position.
- G) Follow instrument instruction procedures for flow meter and needle valve settings.
- H) Press the start switch to begin the timed countdown operation. At the completion of the operation the gas flow will be turned off automatically.

NOTE: To stop a timed run at any point simply push the reset switch.

Bath Operation (continued)

5. Timed Gas and Heat Control (Continued)

Non-dryness automated endpoint - unattended operation

The Automatic 20 system may be used for timed non-dryness endpoint evaporation. In order for this operation to be successful the following parameters must be maintained.

Test Tube Size -	All tubes must be the same size
Sample Volume -	All sample volumes must be equal
Gas Flow Rate -	Must be the same per sample / per position / per run
Bath temperature -	The same set point must be used for each run

A trial run must be made to determine the time required to obtain the specific endpoint desired. Careful notes should be maintained on all operating conditions. Sample size, volume, and gas flow are the most critical, with gas flow being the most difficult to control. Please follow the procedures outlined in the previous section for operation of the timed system with unattended operation and shut down.

The following procedures will help to improve accuracy for each run.

- A) Set the pressure regulator to a position high enough to meet all flow requirements 20 - 30 PSIG should be sufficient for most applications.
- B) Open each valve with sample 1.5 revolutions.
- C) Gas flow to each position should be increased to 0.5 LPM / Position.
- D) Samples should be equally distributed around the bath.
- E) Position each needle or pipet at the same distance from the sample surface. This position should not be altered during the run and should be duplicated on successive runs.
- G) Follow same procedures on page 18 for operation of instrument.
- F) Maintain a log of all operating conditions and positions for future use.
- H) To check samples at any point of evaporation cycle, flip automatic/manual switch to "up" position.

Experimentation has demonstrated that evaporation rate at a given temperature range is largely a function of gas flow rate, 92%. Minor fluctuation in temperature +/- 2 degrees Celsius have little impact on rate, less than 8%. At endpoint, evaporative losses by heat alone are negligible for short periods of time, 10 - 30 minutes, except for very volatile compounds.

Maintenance and Cleaning

The N-EVAP Evaporation system is manufactured from extremely durable materials and may last for years if operated and maintained properly. The following guidelines are recommended for use with N-EVAP systems.

- Heating Media- Tap water, distilled water, de-ionized water and bath heating oils may be used. Distilled and de-ionized water are preferred as they reduce scale and mineral buildup on bath walls.
- Do not use Paraffin (wax) or dry media (sand, alumina, etc.)
Do not use organic solvents as a heating medium.
- Algaecide- The use of algaecide in the bath water poses no threat to the water bath and will keep biological materials under control. Algaecide should not be acidic. Verify type of algaecide used to insure that it will not adversely affect the samples being processed.
- Recommended Algaecides:
- VWR brand - Clear Bath®
Fisher Scientific Brand - Bath Clear®
- Follow manufacturer instructions concerning use and disposal of these materials.
- Water Changes- The bath water should be changed once per week (recommended), but not less than once per month.
- Acidic Environment - When in contact with or exposed to acidic materials, vapors, or samples. The instrument should be cleaned immediately after use and neutralized with a suitable mild base solution of sodium bicarbonate or similar material followed by a clean water wipe. Prolonged contact with acidic materials may damage the instrument unless precautions are taken.
- Needles- Needles should be solvent cleaned after every use to reduce the chance of contamination. Solvent rinsing, autoclaving, and Soxhlet Extracting are viable techniques.

SYMPTOMS	CAUSES	SOLUTIONS
No Power to bath.	Electrical outlet not energized. Bath power cord not plugged in. GFCI not reset. Internal electrical fault.	Energize electrical outlet. Plug in bath power cord. Reset light gray switch on GFCI. Contact OAI for instructions.
Bath does not heat. (heat light is on)	Improper control setting Bad wire connection. Defective digital temperature control or relay.	Check temperature setting Bath will require service, contact OAI for instructions.
No temperature control. (temperature continues to rise)	Defective controller	Replace controller, contact OAI for instructions.
Bath will not heat above 65 - 75 C.	Open faced bath, no cover disk. One of two heaters defective. Defective high temp. switch Defective controller	Purchase anti-evaporation floats. Replace heater, switch, or controller, contact OAI for instructions.
GFCI trips or will not reset.	Water in bath causing leakage. Defective GFCI.	Refer to “water in bath” section. Replace GFCI.
Water inside bath.	Water floods in hood. Leaky bath drain fitting. Bath surface spill. Pinhole in bath pan.	Consult OAI, do not disable GFCI - serious safety hazard. Disassemble bath, dry all contents thoroughly. Return for service highly recommended.
Rust in bath or equipment.	Use of acidic materials in or near equipment.	Clean carefully with steel wool. Remove source of acidic presence. Return unit to factory to be coated in PTFE.
Phthalate Contamination	Human error	Exercise better handling procedures, avoid latex gloves, hand cream, rubber tubing.
Inconsistent evaporation rates. (or excessive nitrogen use)	Nitrogen leaks. Incorrect needle valve adjustment	Check all connections, soap/water. Close needle valves - open valves one revolution and adjust flow using flow meter.
Biological growths in bath	Algae, molds, etc. in bath water	Use algaecide, change bath water once per week.

120 VOLT

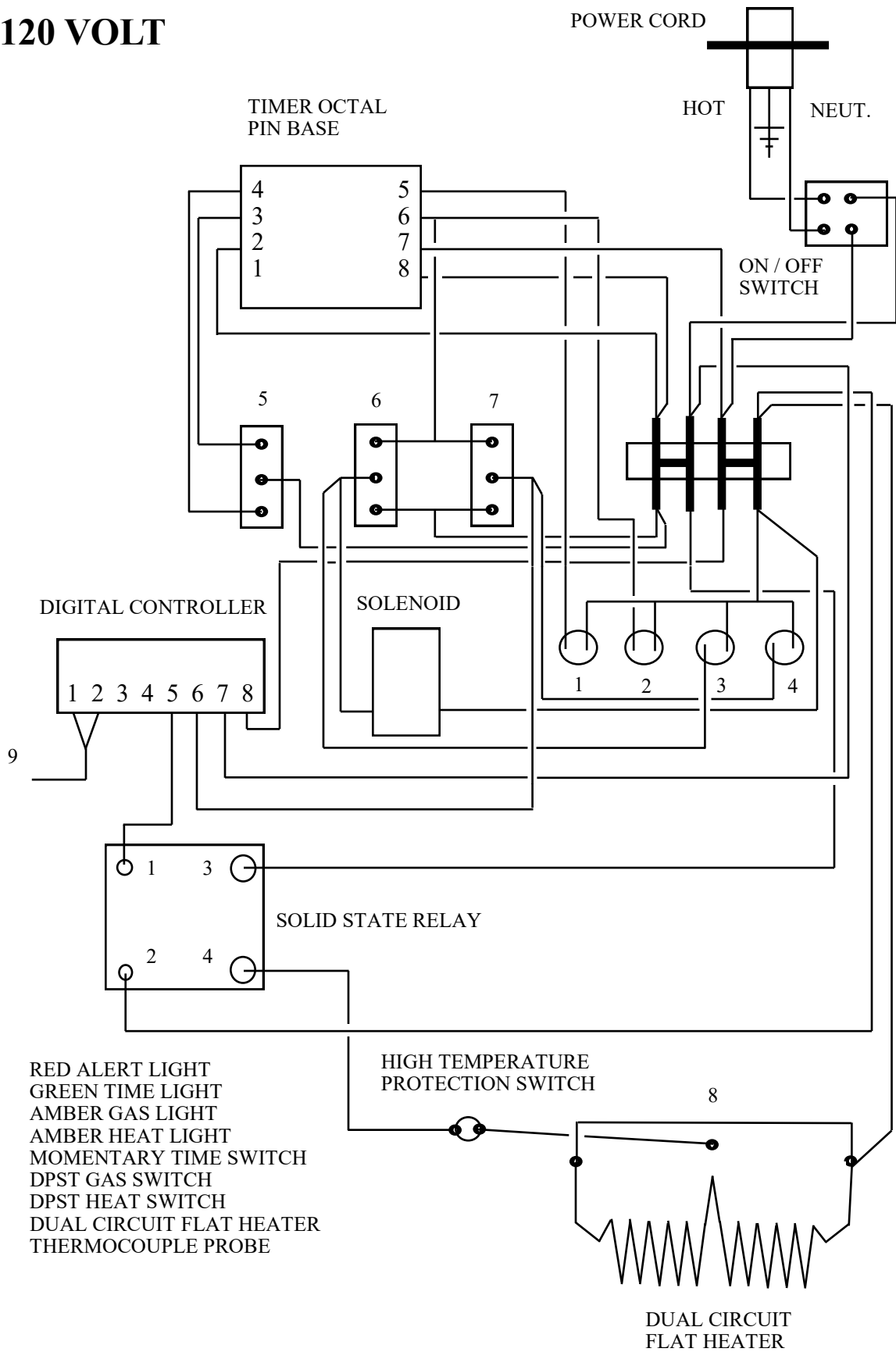

240 VOLT

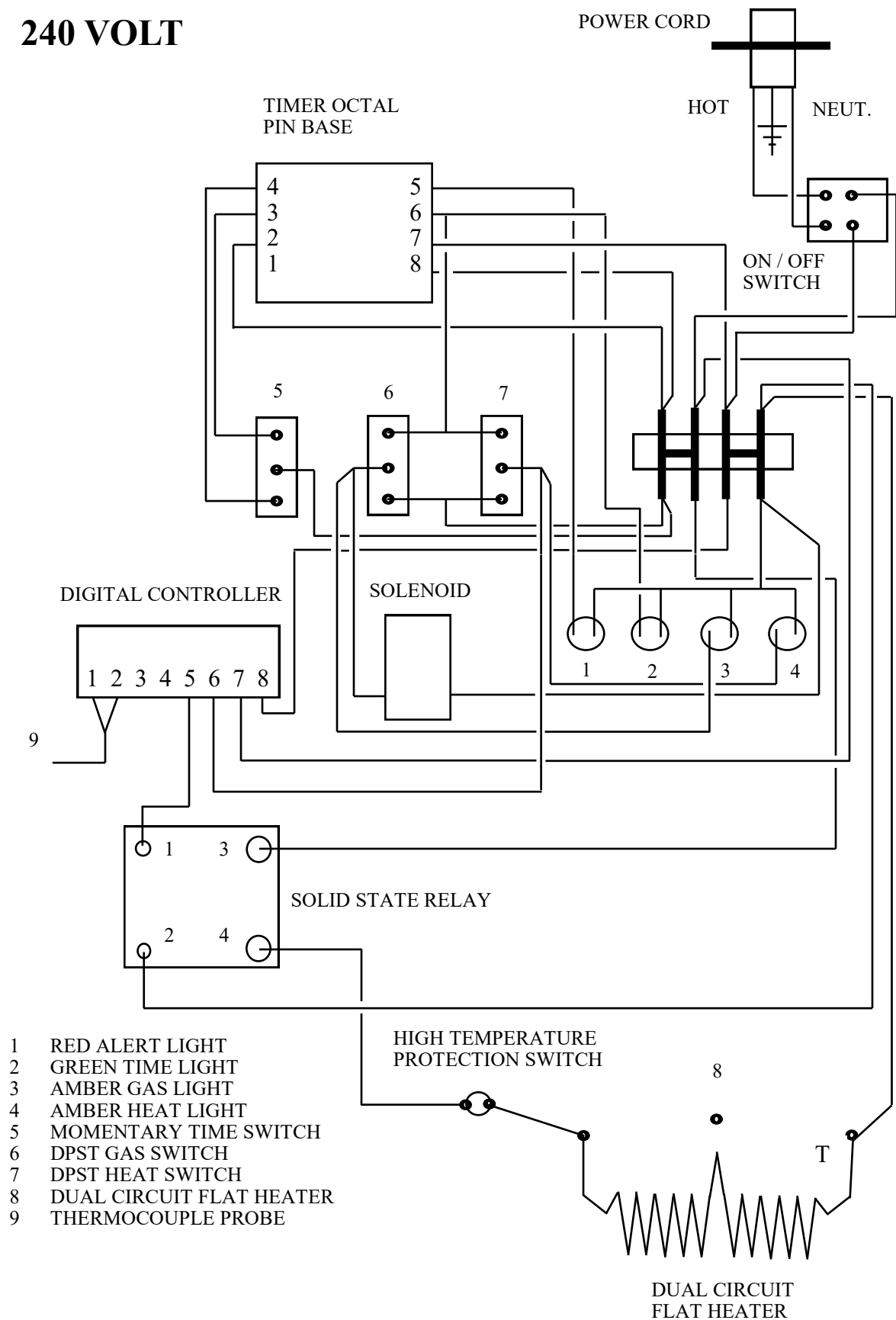

Service and Returns

In the event a product purchased from Organomation needs service or must be returned please follow the outlined procedures below.

1) **Contact Organomation Technical Support Department**

Before returning any product to Organomation Associates for any reason, please contact the Technical Support Department, toll free at 888-838-7300 or email sales@organomation.com to obtain a Return Authorization Form. Support is available Monday through Friday from 9:00 AM to 4:30 PM EST. Support is available free of charge to customers of Organomation in good standing for all products manufactured by Organomation.

2) **Pack the product for return shipment**

The product should be packaged in its original shipping carton if available. If other packaging is required, use a suitable shipping container which will allow a minimum of two (2) inches clearance between the product and the side walls of the shipping carton. Peanuts, semi rigid foam, cardboard, and other items may be used inside for packaging. Care should be taken when packaging heavy items. Some packaging, such as peanuts, will allow the item to shift in transit and may result in damage.

3) **Insurance**

Most common carriers offer insurance. UPS and Federal Express automatically insure your product up to \$100.00 without charge. It is highly recommended that you insure your product. **Organomation is not liable for any return shipping damages.**

4) **Documentation**

When returning items to Organomation, a Return Authorization Form must be included with the following information: Contact persons name and phone number, return address, and statement of the problem.

5) **How will your return be handled?**

Organomation will evaluate the returned item for damage. If the return is a repair, the product will be examined for problems and a repair estimate will be made. The contact person will be contacted, at which time a Purchase Order will be requested. After the PO is issued, the product will be repaired and return shipped. Most repairs are done within a 24 hour period. Return for credit items will be evaluated and your account credited after the item is received. The contact person will be notified immediately in the event any shipping damage has occurred. A restocking fee will be assessed on all returns after 30 days, contact OAI for return authorization and costs prior to return.

Shipping - Claims for damage and shortage

Organomation Associates Inc. makes a sincere effort to ensure your purchase is properly packed and all items listed on the packing slip are in fact enclosed with the shipment. In the event that your purchase is damaged or if any items are missing, please follow the procedures below.

- 1) All packaging materials must be retained until the issue is resolved.
- 2) Thoroughly search all packing materials for the missing items. Review your packing list for back ordered items and the manual for a list of items affiliated with your purchase.
- 3) Contact Organomation immediately at 888-838-7300 or sales@organomation.com.
- 4) If a damaged item needs to be replaced, Organomation will send this item under warranty at no charge. The damaged item must be returned to Organomation. Please follow the instructions listed in the Service and Returns section. **Important - items not returned or which are further damaged or destroyed in transit are the responsibility of the customer and will be billable.**
- 5) No claims for shipping damage or shortage will be accepted after 15 days of receipt of the items by the purchaser.

All items should be returned to:

**Organomation Associates, Inc.
266 River Road West
Berlin, MA 01503**

A RAN (Return Authorization Number) is required prior to all returns.

Specifications

Environmental: Humidity 0-90%, Temperature 5-40° C, Indoor use only. Elevation up to 3000 meters.

Electrical Requirements: 120 or 240 VAC single phase, 50 - 60 Hz.
3 wire grounded outlet required.
GFCI (Ground Fault Circuit Interrupter) optional.
Heating system 1100W*

* 240V units divide wattage by 2.

**Electrical Compliances:
(as marked on bath)**

Optional EC compliance EN55014.

Bath Water:

Regular tap, distilled, or de-ionized water. Manual addition, Fill to 0.5 inch (12mm) from rim.

Gas Services :

Nitrogen, clean air, or other inert gas,
5 - 30 Psig, adjustable.
Flow indication standard with all complete N-EVAP systems.
Quiet air compressor available.

Sample Sizes Accepted:

Glass or Plastic Test Tubes, 10–30mm Dia. x 10-150mm Long
Scintillation Vials.
Centrifuge Tubes (size range above)
Auto sampler vials (size range above)
Consult OAI for optional smaller & larger sizes.

Sample Types Utilized:

Organic Solvents with Boiling Point range 30 - 140 Celsius.
Water and aqueous solutions.
Strong acidic or base materials, PTFE coating required - consult OAI.

Safety Provisions

3 wire grounded power cord.
High Temperature Protection Switch
Stainless Steel and Aluminum construction.
Digital temperature controlled heating system.
Optional PTFE Coating
Optional Type-Z intrinsically safe bath purge.

CE Declaration of Conformity Revised June 1, 2015

We, Organomation Associates Inc a corporation registered in Massachusetts, United States of America, declare under sole responsibility that the following equipment to which this declaration relates, meets the principal protection requirements and is in conformity with relevant sections of the applicable CE standards and other normative documents. If changes are made to the products covered by this declaration then the declaration is no longer valid.

Equipment type: Laboratory sample preparation instruments.
Bench top size, multiple sample position.
Analytical evaporators and extractors.

Model(s): N-EVAP Nitrogen evaporator models:
11106, 11155, 11250, 11634, 11645
MULTIVAP Nitrogen evaporator models:
11364, 11300, 11809, 11830, 11848, 11880
11801, 11803, 11815, 11824
S-EVAP solvent evaporator models:
12060, 12080, 12008
12027, 12037, 12010, 12018, 12048

Rot-X-Tract-S solid-liquid extractor models:
13070, 13090, 13008
Rot-X-Tract-L liquid-liquid extractor models:
13318, 13308

All of the above wired for 110 and 220 volts (-2 option code).
All of the above with dry bath and aluminum beads (-DA option code).
All of the above with acid resistant coatings (-RT option code).
All of the above with intrinsically safe, purged bath case (-Z option code).

EC Directives and Amendments: 89/336/EEC - Electromagnetic Compatibility Directive (EMC).

Harmonized Standards and IEC publications used: EN61326, EN61010-1

Authorized signature	Title	Date
	President	June 1, 2015

CE Declaration of Conformity 2015